

Nikon

Photomic Finder DP-11

フォトミック ファインダー DP-11

REPAIR MANUAL

修理 指 針



NIPPON KOGAKU K.K.

Tokyo, Japan

CONTENTS

I. Repair manual

	Page
1. Marks in the parts list.....	1
2. Lubricant and binding agent list	3 - 4
3. Specifications	5
4. Illustrations.....	7 - 11
5. Electrical connections	12
6. Adjustment of the Ready-light	14
7. Adjustment and assembly	16
7.1 T-dial unit (Fig.4).....	16
7.2 T-film and F-figure (Fig.2, Fig.4)	16
7.3 Resistor unit and its related parts (Fig.3)	18
7.4 Panta unit	20
7.5 Ready light for speedlight	20
7.6 Light measuring accuracy	20
7.7 Adjustment of the voltage of the power source check	20

II. Parts list

1. Parts list	1 - 22
2. Subassembly list	23 - 25

目 次

1. 修理指針



























1. 記号説明	2
2. 潤滑剤・接着剤一覧表	3 - 4
3. 主要諸元	6
4. 展開図 (組立図・接着給油)	7 - 11
5. 回路図	13
6. ストロボライトの調整	15
7. 調整と組立	17
7.1 Tダイアル部 (Fig.4)	17
7.2 Tフィルム・F文字 (Fig.4, Fig.2)	17
7.3 印刷抵抗体関係 (Fig.3)	19
7.4 パンタ系	21
7.5 ストロボレディライト	21
7.6 測光槽度	21
7.7 電源チェック電圧調整	21

2. 部品表

1. 部品表	1 - 22
2. 部組品表	23 - 25

1. Marks in the parts list 記号説明

(1) Standard mechanical elements 標準機械要素

Mark 記号	Shape 形状	Name 名称	Mark 記号	Shape 形状	Name 名称
JCIS ⊕ PM		JCIS Pan Head Machine Screw JCIS 十字穴付きなべ小ねじ	HS		Hexagon Socket Head Set Screw 六角穴付き止めねじ
JCIS ⊕ CM		JCIS Countersunk Head Machine Screw JCIS 十字穴付きさら小ねじ	HSB		Hexagon Socket Head Bolt 六角穴付きボルト
JCIS ⊕ OCM		JCIS Oval Countersunk Head Machine Screw JCIS 十字穴付き丸さら小ねじ	(45°)P		Oval Countersunk Head Special Machine Screw すりわり付き特殊丸さら小ねじ
⊕ PM		Pan Head Machine Screw 十字穴付きなべ小ねじ	(45°)Q		Countersunk Head Special Machine Screw すりわり付き特殊さら小ねじ
⊕ CM		Countersunk Head Machine Screw 十字穴付きさら小ねじ	⊕ PTB		Pan Head Tapping Screw Type B 十字穴付きなべタッピンねじB
⊕ OCM		Oval Countersunk Head Machine Screw 十字穴付き丸さら小ねじ	⊕ CTB		Countersunk Head Tapping Screw Type B 十字穴付きさらタッピンねじB
⊕ RM		Round Head Machine Screw 十字穴付き丸小ねじ	⊕ OCTB		Oval Countersunk Head Tapping Screw Type B 十字穴付き丸さらタッピンねじB
⊕ TM		Truss Head Machine Screw 十字穴付きトラス小ねじ	⊕ PT		Pan Head Tapping Screw 十字穴付きなべタッピンねじ
SR		Set Screw Round Point すりわり付き止めねじ丸さき	⊕ CT		Countersunk Head Tapping Screw 十字穴付きさらタッピンねじ
SC		Set Screw Cone Point すりわり付き止めねじとがりさき	⊕ OCT		Oval Countersunk Head Tapping Screw 十字穴付き丸さらタッピンねじ
SH		Set Screw Half Point すりわり付き止めねじくぼみさき	N		Hexagon Nut 六角ナット
TP		Taper Pin テーパピン	SPP		Spring Pin スプリングピン
STP		Straight Pin 平行ピン	E		E-ring E型止め輪

Expression 表示法

☆ Standard screw 標準ねじ

Mark, Diameter × Pitch × Length, Type or Mark, Diameter × Length, Type
 記号 ねじの呼び径 ピッチ 長さ 種別 又は 記号 ねじの呼び径 長さ 種別

Ex. ⊕ RM 3×0.5×4

JCIS ⊕ PM 2×2.5 Type (3)

☆ Pin ピン

Mark, Diameter × Length
 記号 呼び径 長さ

Ex. TP 2×12

☆ Nut ナット

Diameter of internal thread, Mark-Type
 ねじの呼び径 記号 種別

Ex. 8N-Type (3)

☆ E-ring E型止め輪

Mark-Diameter
 記号 呼び径

Ex. E-8

(2) The term of sale column 販売区分欄

Mark 記号	Explanation 説明
○	Can be supplied individually 単独部品として販売するもの
△	Not supplied individually but only as subassembly 部組品でなければ販売しないもの
○△	Supplied either as part or subassembly 単独部品でも部組品でも販売するもの
×	Not considered as repair part 修理部品とは考えないもの
*	Should be sent to the factory if the repair is needed 単体では交換できないので、組む場合に工場での加工が必要なもの
☐	Delivered as a product from the sales department (i.e., not supplied as repair part) 商品として販売店で販売しているもの(修理部品扱いではない)

(3) The remarks column 備考欄

S-0001	Part number used in common 共通部品番号
D-2222	Part number in stock 貯蔵品番号
51F1001	Technical data sheet number 製品技術資料番号
-1×100/1000	Starting order 実施オーダー
Rev.	Revision 訂正
Add.	Addition 追加
Dis.	Discontinuation 廃止
# 1-# 3	Relative parts number 関係部品番号

2. Lubricant and binding agent list 潤滑剤・接着剤一覧表

LUBRICANTS 潤滑剤						
Oil 油	Usage 用途	Items number 番号	Items 商品名		Remarks 備考	
			Japanese	日本		
Liquid oil 液体油	At a normal temperature 常温用	L 1212	日本石油	イソピンドル油 No.5		
		L 1233	シエル石油	トナオイル #33		
		L 1309	モービル石油	モービループ HD80-90		
		L 1314	モービル石油	モービループ HD140		
	At a low temperature 低温用	L 2010	ウイリアム・エフ・ナイ(本村産業)	アストロオイル		
		L 2113	三達化工	D. O. S		
		L 2215	エクリプス・バイオニア	エクリプス・バイオニア #10(ジャイロ油)		
		L 3016	理研製油	スクワレル I. A-10		
		L 3025	理研製油	スクワレル M-1		
		L 3034	理研製油	スクワレル M-2		
		L 3044	理研製油	スクワレル M-5		
		L 3047	理研製油	スクワレル H-1		
	Grease oil グリース	At a normal temperature 常温用	G 5201	社内調合		
			G 5204	社内調合		
G 5214			社内調合			
G 6053			日本鉱油	パーマルブ H1003		
G 6252			出光興産	ダフニコロネックス 2		
G 6372			シエル石油	シエルアルバニア 2		
G 6414			杉浦研究所	光学用グリース Z-2		
G 6433			杉浦研究所	光学用グリース X-2		
G 7821			丸善石油	リマックス 2		
G 8681			ロックレー(大東商事)	リキモリオート LM-81		
At a low temperature 低温用		G 7100	理研製油	スクワグリース L-2		
		G 7811	日本鉱油	フォートルブ 024		
		G 7812	日本鉱油	フォートルブ 025		
		G 7813	社内調合			
		G 7814	協同油脂	マルテンブPS No.1		
		G 7815	協同油脂	マルテンブPS No.2		
		G 7833	東レシリコーン	シリコーンSH.33(F)グリース		
		G 7848	日本石油	ユニテンブグリース		
G 7854	日本鉱油	パーマルブ C-1				
G 7855	日本鉱油	パーマルブ C-2				

LUBRICANTS 潤滑油

Oil 油	Usage 用途	Items number 番号	Items 商品名		Remarks 備考	
			Japanese 日本			
Grease oil グリース	At a low temperature 低温用	G 7856	日本鉱油	パーマルプ C-3		
		G 7862	日本鉱油	パーマルプ D-2		
		G 7866	日本鉱油	フォートルプ 023		
		G 7870	モービル石油	モービルグリース 27		
		G 8181	社内調合			
		G 8610	ロックレー(大東商事) リキモリペースター LM-83			
		G 8613	ロックレー(大東商事) リキモリパウダー LM-13			

BINDING AGENTS 接着剤

Usage 用途	Items number 番号	Items 商品名		Remarks 備考
		Japanese 日本		
For leather or rubber goods. 皮類, ゴム類	# 330	スミボンド	VA-1000	
	# 501	ブライオボンド	# 30	
For make metal goods together with metal goods or glass with metal 一般金属相互 ガラスと金属	# 616	セメダインスーパー	(家庭用)	
	# 621	セメダイン#1500	(工業用)	
	# 621	セメダイン#1565		
	# 631	アラルダイト	AT 1	
	# 634	主剤 アラルダイト AY 101 硬化剤 ハードナー HY 951		
	# 645HB, # 645HE	DM K 5		
For temporary adhesion in the process 工程上の仮止め	# 201	セラック	オレンジ色, レモン色可	
	# 350	ねじロック		
	# 410	ロックタイト (B/M黄, ST/L赤 SC/L紫, N/L青, D橙)		
	# 921	アロンアルファ	# 201	
	# 922	アロンアルファ	# 202	
For replenishment 充填を主とする接着	# 503	ウェザーバンシーラー		
	# 506	スリーボンド	# 4	
	# 508	シラシール	3 DW	
	# 512	シラシール	FSXS-1548	
	# 646HB, # 646HE	DM D 6		
	# 647HB, # 647HE	DM K 3		

3. Specifications

- Exposure metering system: TTL, center-weighted, at full aperture
(stop-down metering also possible)
- Metering range: 0.25—16000 Cd/m² (EV 1—17) with 50mm f/1.4 lens at
ASA100, using A-type focusing screen
- Aperture coupling range: 7-1/3 stops (1/3 step compensation not included)
Provided with optical system for indicating
selected value in the finder viewfield.
- Shutter speed range: B, 1—1/2000 sec. Provided with scale coupled to
shutter speed dial in the camera body for indicating
selected value in the finder viewfield.
- Film speed setting range: ASA 6—6400
- Focusing-screen type compensation range: +1/2 — -2EV
- Indications displayed in finder viewfield:
F-number, exposure information (meter needle and index
dot) and shutter speed arranged from left to right at the
bottom of finder viewfield.
For exposure setting, bring the needle to the fixed index
dot. Exposure setting ascertainable also outside the finder
- Ready-light: Built-in. Lighting ascertainable inside and outside the
viewfield.
- Power source: Two silver-oxide batteries, each 1.5V, deposited in the
camera body
- Power source check: By movement of meter needle with check button
- Light receiving element: Two CdSs
- Functional resistor: Printed variable resistor used
- Eyepiece screw thread: 19mm in dia., p=0.75mm, permitting acceptance of
eyepiece auxiliary lens (31FAN), eyeguard (31FA20)
or magnifier (31FD2)
- Finder viewfield ratio: About 100%
- Finder magnification: 0.8x with 50mm f/1.4 lens focused at infinity
- Finder eyepiece diopter: -1 dpt
- To change the finder:
To attach, it suffices only to press down the finder from
above onto the prism box on the camera body, each part
being automatically coupled to the camera body.
To detach, while pressing lightly the finder against the
camera body, depress the finder-release button on the
camera back, and at the same time push the finder-release
lever in the direction of its axis, and turn it clockwise.
The finder will be lifted up.
Note: The above procedure, the same as for F2 Photomic
Finder, is adopted to avoid accidental drop or
rising up caused by maloperation.
- Dimensions: 74.5mm in width, 42.5mm in height, 65.5mm in depth
- Weight: About 200g

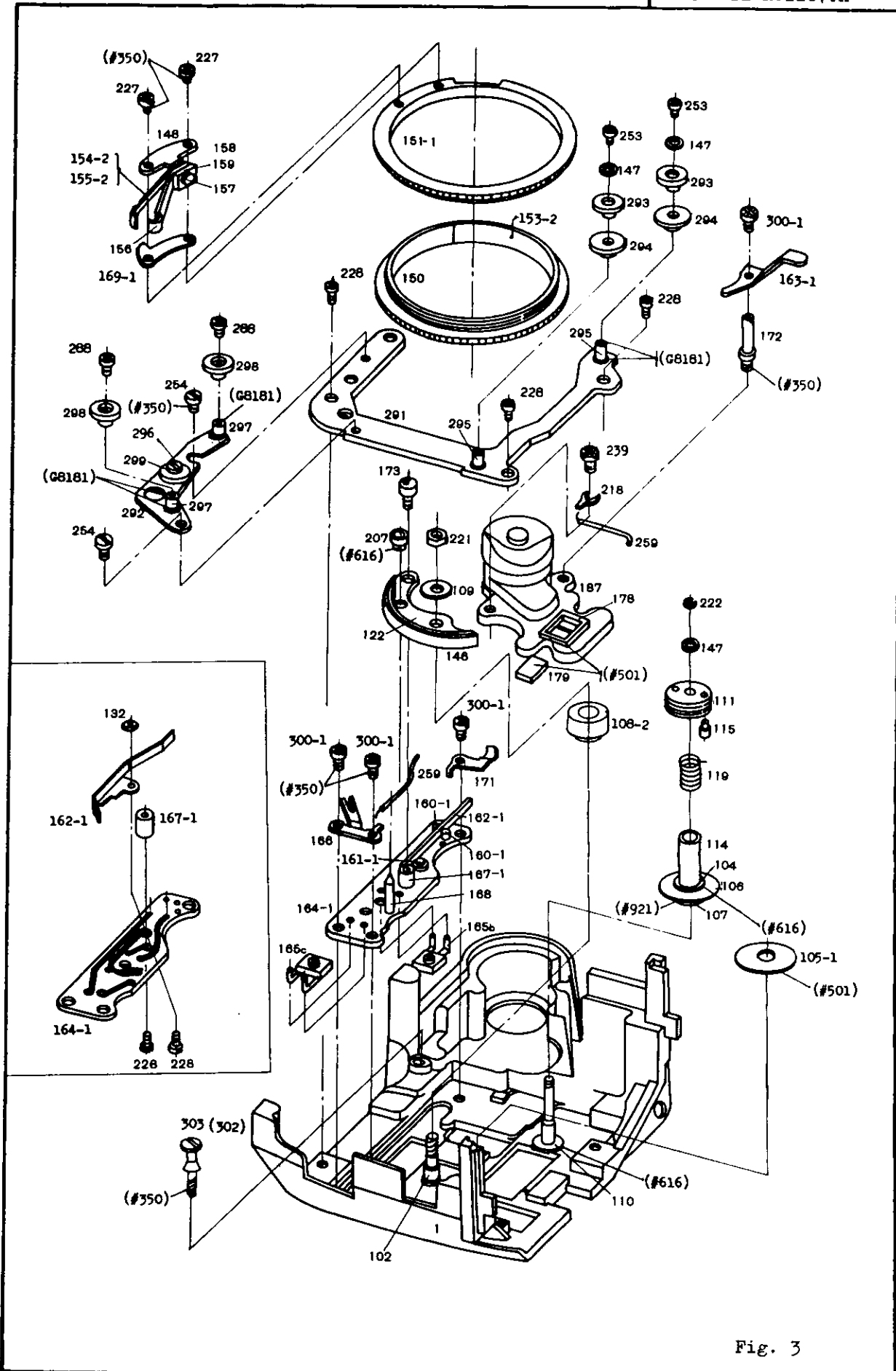

Fig. 3

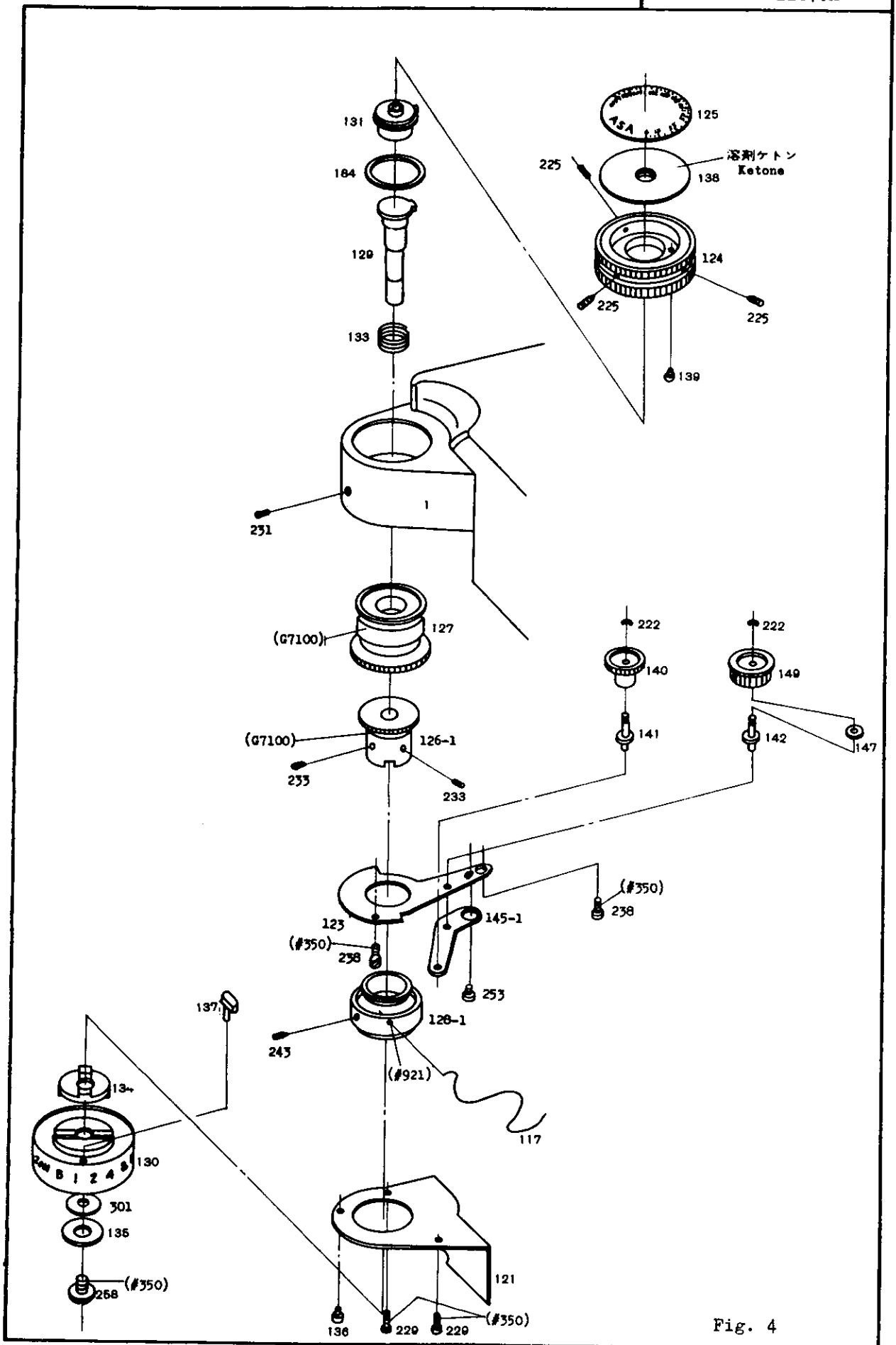

Fig. 4

5 Electrical Connections

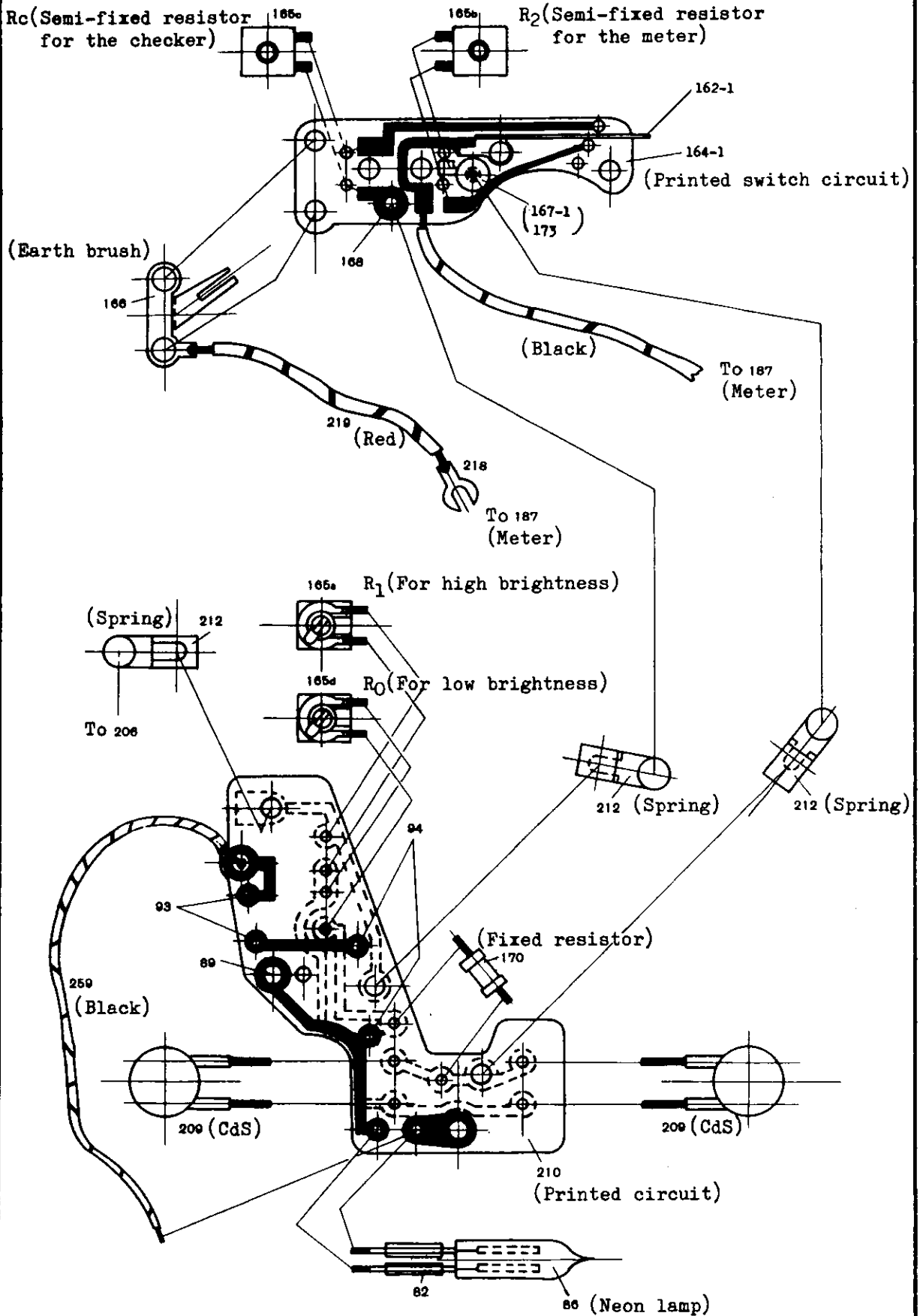
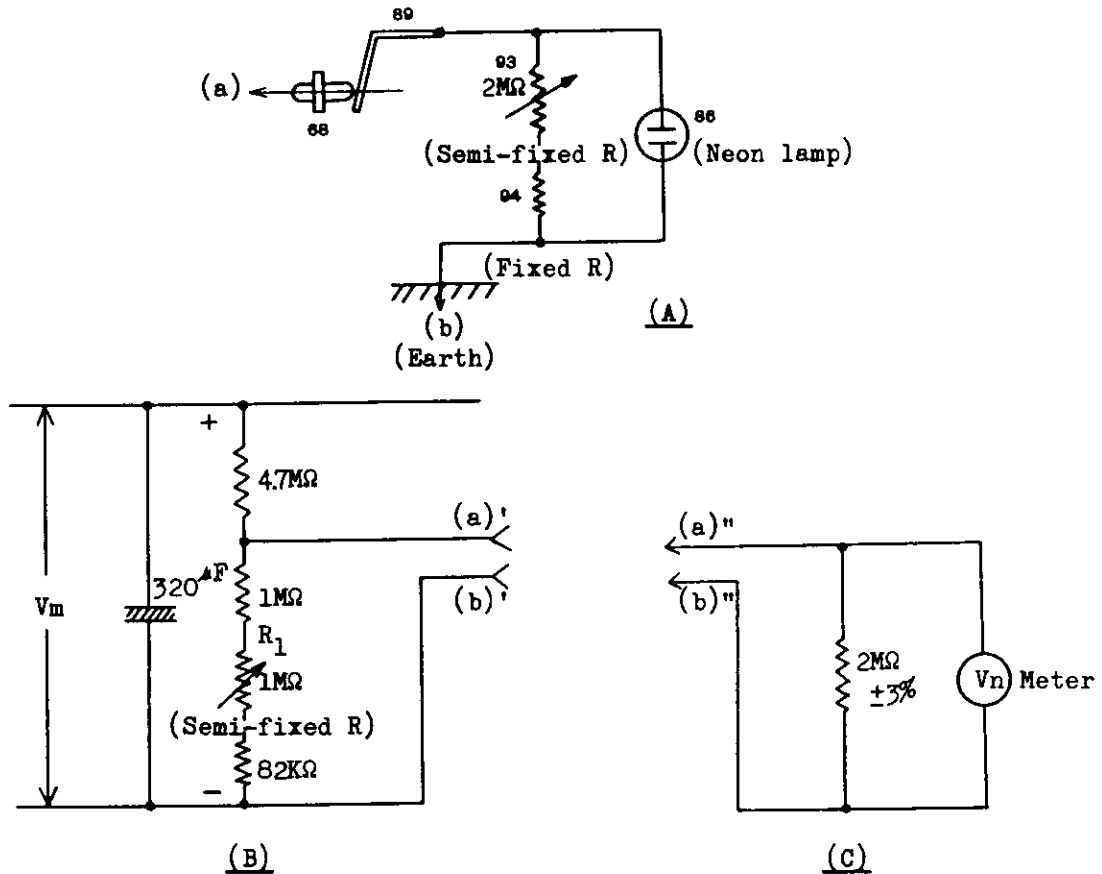

Fig. 6

6. Adjustment of the Ready-Light



Adjustment of lighting voltage for the Neon lamp (#86)

For performing this adjustment, it is necessary to prepare the B-circuits (as tools) and the C-circuit (as a voltmeter), as shown in the above diagrams.

Make a rated power source voltage V_m of each B-circuit 450V.

Connecting one of the B-circuits to the C-circuit (meter), adjust the semi-fixed resistor R_1 in the B-circuit to have the indication 62V on the C-circuit meter (V_n).

Connecting the other B-circuit, make adjustment of the Semi-fixed resistor to have the indication 64V on the C-circuit meter (V_n).

Then, adjust the semi-fixed resistor #93 in the main circuit A, so that the neon lamp (#86) does not light, when the main circuit A is connected to the B-circuit with 62V, but the lamp lights positively, when it is connected to the B-circuit with 64V.

As the voltmeter, use a digital type voltmeter with an input impedance of 10 MΩ.

Fig. 7

7. Adjustment and Reassembly

7.1 T-dial unit (Fig.4)

7.1.1 Film-speed ASA dial #125

Adhere film-speed ASA dial #125 to its base plate #138 in such a position that its relative angle to stopper #131 is as shown in the figure below. Thus, when ASA dial knob #124 is turned fully up to the B-side limit, ASA 6400 scale mark comes opposite the 1-1/2 step index dot (with a spare angle of $3^{\circ}55'$) on the screen-type compensation scale.

7.1.2 Slack of Oldham coupling

Holding ASA dial knob #124 with the left (or right) hand and T-dial #130 with the right (or left) hand, see a slack in the direction of thrust. If it exceeds 0.1mm, adjust it by changing the thickness of setting washer #135.

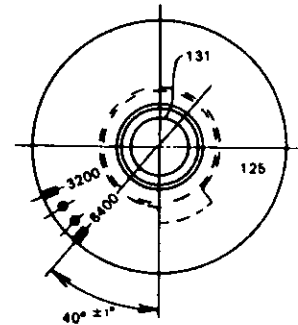

7.2 T-film and F-figure (Fig.2, Fig.4)

7.2.1 T-film #106 (shutter speeds)

For positional adjustment of the T-film #106, first unscrew T-screw #231. Through its screw hole, insert a screwdriver, and turn ASA dial knob #124 to find T-drum screw #243. Release this T-drum screw and turn the ASA dial knob to move the T-film.

Do not draw out the screwdriver until the adjustment is finished and the T-drum screw is fastened.

7.2.2 Mirror G1

Positional adjustment of T-film #106 relative to the finder view-field is carried out just the same as for 20FD11 or 30FD17, not yet modified for AI, that is to say, releasing or fastening set screws #244x2, attached on prism box #2-1, change the inclination of mirror G1, so that the T-figure appears in the specified position relative to the finder viewfield.

7.2.3 F-figure (f-number)

To adjust the position of the F-figure, relative to the finder view-field as well as to the position of the T-film and meter index dot, first, attach the finder to the camera body equipped with the standard lens and the tool front cover, and then change the inclination of mirror G9 by releasing or fastening the set screws #242x2, attached to the F-mirror adjusting plate, until the specified position of the F-figure is obtained.

7.3 Resistor unit and its related parts (Fig.3)

7.3.1 Replacement of roller base plate #291 unit

- (1) Remove T-film pulley #111.
- (2) Unscrew screws #228x3, used for fixing roller base plate #291, and separate the #291 unit upwards. Thereupon, releasing screw #253, used for fixing T-gear adjuster #145-1, disengage T-3rd gear #140 from resistor gear #150.
- (3) Attach the replacement #291 unit to the camera body #1 using screws #228x3. Then, moving the unit laterally and longitudinally so that the best engagement of brush gear #151-1 to R-pinion #152-1 is obtained. At the same time, when brush bracket liner #169-1 is brought against the stopper, adjust the brush gear stopper #303 so that the relative positions of the teeth of the gears are as shown in c) of the figure below.



- a) Replace #303 by #302 (brush gear adjusting stopper)



- b) Replace #303 by #302



- c) Let #303 remain as it is

Make sure of contact pressure of the brushes (#154, #155-1 and #156) to be 50g at least and of rotation torque of #151-1 (along the teeth of the gear) to be less than 15g.

Excessive or deficient pressure may cause reduction to the light measuring accuracy.

- (4) Swinging #145-1 laterally, fix it in the best engaging position of #150 to #140, using screw #253.
- (5) Check for correct operations of panta-unit, T-dial, etc.
- (6) Attach pulley #111 unit in the same way as for 20FD11 not yet modified for AI.

7.3.2 Replacement of resistor gear #150 and brush gear #151-1

After removing roller base plate #291 unit, proceed to replacement of resistor gear #150 and brush gear #151-1 as below:

- (1) Slightly release adjusting screws #254x2 used for fixing roller adjusting plate #292 in position, separate one end of #292 from #150 and #151-1, and dismount #150 and #151-1.

- (2) Fit the replacement #150 and #151-1 (both ready for assembly) to the rollers #293 and #294 of #291 unit, respectively.
- (3) Fit adjusting rollers #298 and #299 to #150 and #151-1, respectively, and, assuring correct rotation of #150 and #151-1, fasten up #254.
- (4) If any decentration of #150 and #151-1, large slack in the direction of their diameter, or not smooth movement takes place, adjust the positions of #150 and #151-1, by eccentricing roller shafts B and C (#296 and #297x2).

7.4 Panta unit

7.4.1 Adjustment of panta retaining lever

Adjust panta retaining stopper #33-1 from the side of front plate #6-1, so that smooth and no slack movement of diaphragm link #65-1 is obtained.

7.4.2 Adjustment of lock lever

Push in diaphragm link #65-1, and adjust the clearance between lock spring lever #29-1 and lock lever #18-1 to 0.8 ± 0.2 mm by eccentricing lock spring retainer #19-1.

7.5 Ready light for speedlight

The circuit is just same as for 20FD11 finders not yet modified for AI. The adjustment also is made correspondingly.

7.6 Light measuring accuracy

The circuit is just same as for 20FD11 finders not yet modified for AI. The adjustment also is made correspondingly.

7.7 Adjustment of the voltage of the power source check











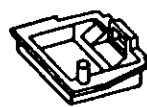

The circuit is just same as for 20FD11 finders not yet modified for AI. The adjustment also is made correspondingly.















PARTS LIST















部 品 表















1. Parts list 部品表











20FD11-R.2107.A











Part No. 部品番号	Name and Shape 名称 および 形状	Pcs. per Unit 1台分個数	Reference Subassembly No. 参照部組品番号	Reference Fig. No. 参照図番	Term of Sale 販売区分	Remarks 備考
1	Body ボデー 	1	AA1	1,4	△	
2-1	Prism box プリズムボックス 	1	BB1, BB2	5	△	
3	CdS holder 受光体ブラケット 	1	C1	5	△	DP-1
4	Top cover 上カバー 	1	D1	1	△	DP-1
Blank 欠						
6-1	Front plate t=0.6 前板 	1	AA1, EE1, EE2	2	△	
7-1	Rear plate t=0.6 後板 	1	AA1, EE1, EE3	2	△	
8-1	Front cover 前カバー 	1	DD2	1	△	
9-1	Segment gear t=0.5 セグメントギア 	1	AA1, EE1, EE3	2	△	
10-1	Segment stopper セグメントストッパー 	1	AA1, EE1, EE3	2	△	
11-1	Segment spring stud セグメントバネ掛け 	1	AA1, EE1, EE3	2	△	
12-1	Segment axle セグメント軸 	1	AA1, EE1, EE3	2	△	
13-1	Segment spring d=0.3 セグメントバネ 	1	AA1, EE1	2	○△	
14-1	Segment spring axle セグメントバネ軸 	1	AA1, EE1, EE2	2	△	
15-1	Hook stopper フック制限 	1	AA1, EE1, EE3	2	△	







Part No. 部品番号	Name and Shape 名称および形状	Pcs. per Unit 1台分個数	Reference Subassembly No. 参照部組品番号	Reference Fig. No. 参照図番	Term of Sale 販売区分	Remarks 備考
16-1	Panta spring axle パンタバネ軸 	1	AA1, EE1,EE2	2	△	
17-1	Panta spring d=0.35 パンタバネ 	1	AA1, EE1	2	○△	
18-1	Lock lever t=0.5 ロックレバー 	1	AA1, EE1,EE3	2	△	
19-1	Lock spring retainer ロックバネ掛け 	1	AA1, EE1,EE2	2	△	
20-1	Lock lever spring axle ロックレバーバネ軸 	1	AA1, EE1,EE2	2	△	
21-1	Lock spring d=0.5 ロックバネ 	1	AA1 EE1	2	○△	
22-1	Panta thrust pin パンタ受ピン 	1	AA1 EE1,EE3	2	△	
23-1	Release knob 解除ノブ 	1	DD2	1	△	
24-1	Panta A stopper rivet パンタA振れ止め鉚 	7	AA1,EE1, EE2,EE3	2	△	
25-1	Release knob plate t=0.4 解除ノブ板 	1	DD2	1	△	
26-1	Rear plate stand A 後板支柱A 	3	AA1,EE1 EE2,EE3	2	△	
27	Collar カラー 	1		5	○	DP-1
28-1	Release knob axle 解除ノブ軸 	1	DD2	1	△	
29-1	Lock spring lever ロックバネレバー 	1	AA1, EE1,EE2	2	△	
30-1	Release knob base plate t=0.1 解除ノブ受板 	1	DD2	1	△	











Part No. 部品番号	Name and Shape 名称および形状	Pcs. per Unit 1台分個数	Reference Subassembly No. 参照部組品番号	Reference Fig. No. 参照図番	Term of Sale 販売区分	Remarks 備考
31-1	Panta spring stud パンタバネ掛け 	1	AA1, EE1,EE2	2	△	
32-1	Panta retaining lever t=0.4 パンタ押えレバー 	1	AA1, EE1,EE3	2	△	
33-1	Panta retaining stopper パンタ押えレバー制限 	1	AA1, EE1,EE3	2	△	
34-1	Panta retaining spring d=0.23 パンタ押えレバーバネ 	1	AA1, EE1,EE3	2	△	
35-1	Rear plate stand 後板支柱C 	1	AA1, EE1,EE3	2	△	
36-1	Panta retaining spring stud パンタ押えレバーバネ掛け 	1	AA1, EE1,EE3	2	△	
37-1	R pinion axle Rピニオン軸 	1	AA1, EE1,EE2	2	△	
38-1	Prism retention plate t=0.3 プリズム保持板 	1	CC6	2	△	
39-1	F mirror retention plate t=0.2 Fミラー保持板 	1	CC5	2	△	
40-1	F mirror adjustor t=0.8 Fミラー調整板 	1	CC5	2	△	
41-1	F mirror adjustor rivet Fミラー調整板釘 	2	AA1, EE1,EE2	2	△	
42-1	F mirror retention screw - 1.4 × 1.2 Fミラー保持板ビス 	1	CC5	2	△	
43-1	Panta pin B パンタピンB 	1	AA1, EE1,EE2	2	△	
44-1	Panta C washer 1×3×0.6 パンタC座金 	1	AA1, EE1,EE2	2	△	
45-1	Panta axle パンタ軸 	1	AA1, EE1,EE2	2	△	

Part No. 部品番号	Name and Shape 名称および形状	Pcs. per Unit 1台分個数	Reference Subassembly No. 参照部組品番号	Reference Fig. No. 参照図番	Term of Sale 販売区分	Remarks 備考
46-1	Panta stopper パンタ振れ止め 	1	AA1, EE1,EE3	2	△	
47-1	Segment pin セグメントバネピン 	1	AA1, EE1,EE2	2	△	
48-1	Cover plate t=0.05 目かくし板 	1	DD2	1	△	
49-1	F aperture mask t=0.1 F視野枠 	1	DD2	1	△	
50-1	F mask A t=0.1 FマスクA 	1		2	○	
51-1	F mask B t=0.07 FマスクB 	1	CC3	5	△	
52-1	Stopper plate t=0.3 振れ止め板 	1	AA1, EE1,EE3	2	△	
53-1	F mirror nut Fミラーナット 	2		2	○	
54-1	Rear plate stand B 後板支柱B 	1	AA1, EE1,EE3	2	△	
55-1	Release coupling axle 着脱運動環軸 	1	AA1, EE1,EE3	2	△	
56-1	Guided rail ガイドレール 	1	AA1, EE1,EE2	2	△	
57-1	Panta D パンタD 	1	AA1, EE1,EE2	2	△	
58-1	Panta A パンタA 	1	AA1, EE1,EE2	2	△	
59-1	Panta B パンタB 	1	AA1, EE1,EE2	2	△	
60-1	Panta C パンタC 	1	AA1, EE1,EE2	2	△	















Part No. 部品番号	Name and Shape 名称および形状	Pcs. per Unit 1台分個数	Reference Subassembly No. 参照部組品番号	Reference Fig. No. 参照図番	Term of Sale 販売区分	Remarks 備考
61-1	Panta pin パンタピン 	1	AA1, EE1,EE2	2	△	
62-1	Link axle 連動板軸 	1	AA1, EE1	2	○△	
63-1	Panta long pin パンタ長ピン 	1	AA1, EE1,EE2	2	△	
64-1	Panta pin A パンタピンA 	1	AA1, EE1,EE2	2	△	
65-1	Diaphragm link 絞り連動板 	1	AA1, EE1,EE2	2	△	
66-1	Panta washer 2.1x4x0.2 パンタ座金 	1	AA1,EE1	2	○△	
Blank 欠						
68	Terminal ターミナル 	1	D1	1,7	△	DP-1
69	Terminal mold ターミナルモールド 	1	D1	1	△	DP-1
70-1	Spring mount roll ハネ掛けコロ 	1	EE1	2	○△	
71	Terminal insulator washer 1.7x3.7x0.4 ターミナル絶縁ワッシャー 	1	D1	1	△	S-2037 DP-1
Blank 欠						
Blank 欠						
Blank 欠						
Blank 欠						

Part No. 部品番号	Name and Shape 名称および形状	Pcs. per Unit 1台分個数	Reference Subassembly No. 参照部組品番号	Reference Fig. No. 参照図番	Term of Sale 販売区分	Remarks 備考
Blank 欠						
Blank 欠						
78-1	Panta pin C パンタピンC 	1	AA1, EE1,EE2	2	△	
79-1	R idle axle Rアイドル軸 	1	AA1, EE1,EE3	2	△	
80-1A	R 1st gear R一番ギア 	1	AA1, EE1,EE3	2	△	
80-1B	R 1st axle R一番軸 	1	AA1, EE1,EE3	2	△	
81-1	R idle gear Rアイドルギア 	1	AA1, EE1,EE3	2	△	
82	Insulator pipe 絶縁パイプ 	2	F1	5,6	○△	S-3053 DP-1
83-1	R slack spring d=0.2 Rスラックバネ 	1	AA1,EE1	2	○△	
84-1	R slack barrel Rスラックバネ筒 	1	AA1, EE1,EE2	2	△	
85	Terminal fixed washer 1.7×3.5×0.4 ターミナルカシメワッシャー 	1	D1	1	△	S-2003 DP-1
86	Neon discharge tube ネオン放電管	1	F1	5,6,7	○△	S-4241 DP-1
Blank 欠						
Blank 欠						
89	Spring contact t=0.2 ランプ用接点バネ 	1	F1	5,6,7	○△	DP-1

Part No. 部品番号	Name and Shape 名称および形状	Pcs. per Unit 1台分個数	Reference Subassembly No. 参照部組品番号	Reference Fig. No. 参照図番	Term of Sale 販売区分	Remarks 備考
Blank 欠						
Blank 欠						
Blank 欠						
93	Semi-fixed resistor ストロボランプ用半固定抵抗 	1	F1	5,6,7	○△	DP-1 S-4239
94A	Fixed-resistor A ストロボランプ用固定抵抗 A 	1	F1	5,6,7	○△	DP-1 S-4242
94B	Fixed-resistor B ストロボランプ用固定抵抗 B 	1	F1	5,6,7	○△	DP-1 S-4243
Blank 欠						
Blank 欠						
97	Top cover leatherette t=0.5 上カバー貼り革 	1		1	○	DP-1
98	Adjusting dust cover 調整穴かくし 	1	AA1	1,5	○△	DP-1
Blank 欠						
Blank 欠						
Blank 欠						
102	Common contact base stud 接触板支柱 	1	AA1	1,3	△	DP-1
Blank 欠						















Part No. 部品番号	Name and Shape 名称および形状	Pcs. per Unit 1台分個数	Reference Subassembly No. 参照部組品番号	Reference Fig. No. 参照図番	Term of Sale 販売区分	Remarks 備考
104	T-film washer 3.7x6x0.1 Tフィルムワッシャー 	1	AA1,T1	3	△	DP-1
105-1	F-light baffle plate t=0.2 F遮光板 	1	AA1	3	△	
106	T-film t=0.1 Tフィルム 	1	AA1,T1	3	△	DP-1 S-3057
107	T-film washer Tフィルム座板 	1	AA1,T1	3	△	DP-1
108-2	Contact collar 接触板カラー 	1	AA1,HH1	3	△	
109	Contact washer 2.2x6x0.2 接触板ワッシャー 	1	AA1	3	△	DP-1 S-2046
110	T-film axle Tフィルム軸 	1	AA1	1,3	△	DP-1
111	T-film pulley Tフィルムプーリー 	1	AA1,T2,T3	3	△	DP-1
Blank 欠						
Blank 欠						
114	T-film boss Tフィルムボス 	1	AA1,T1	3	△	DP-1
115	T-pulley locating pin Tプーリー位置決めピン 	1	AA1,T2,T3	3	△	DP-1 S-1081
Blank 欠						
117	Thread d=0.35 糸 	1	AA1,T2	4	○△	DP-1
Blank 欠						















Part No. 部品番号	Name and Shape 名称 および 形状	Pcs. per Unit 1台分個数	Reference Subassembly No. 参照部組品番号	Reference Fig. No. 参照図番	Term of Sale 販売区分	Remarks 備考
119	T-film spring d=0.26 Tフィルムバネ 	1	AA1	3	○△	DP-1 S-1578
Blank 欠						
121	T-bottom cover t=0.7 T底板 	1	AA1,T4	4	△	DP-1
122	Common contact base 接触板 	1	AA1,HH1	3	△	DP-1
123	Racket plate t=0.8 羽子板 	1	AA1,T5	4	△	DP-1
124	ASA dial knob ASAツマミ 	1	AA1,T6	4	△	DP-1
125	ASAdial t=0.2 ASA感度目盛板 	1	AA1,T6	4	○△	DP-1
126-1	Clutch クラッチ 	1	AA1	4	○△	DP-1
127	Clutch gear クラッチギア 	1	AA1	4	○△	DP-1
128-1	T-drum Tドラム 	1	AA1,T2	4	○△	DP-1
129	T-dial shaft Tダイヤル軸 	1	AA1	4	○△	DP-1
130	T-dial Tダイヤル 	1	AA1,T7	4	△	DP-1
131	ASA dial stopper ASA制限 	1	AA1,T6	4	△	DP-1
132	M1.7 × 1 ナット	4	F1	5	○△	DP-1 S-2204A
133	Clutch spring d=0.5 クラッチバネ 	1	AA1	4	○△	DP-1

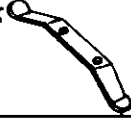
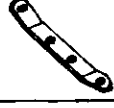













Part No. 部品番号	Name and Shape 名称 および 形状	Pcs. per Unit 1台分個数	Reference Subassembly No. 参照部組品番号	Reference Fig. No. 参照図番	Term of Sale 販売区分	Remarks 備考
134	Coupling ring 連結板 	1	AA1	4	○△	DP-1
135	Washer 0.4 A 0.7 D 3×7.8× 0.5 B 0.8 E 止めワッシャー 0.6 C 	各 1	AA1	4	○△	DP-1
136	T-stopper pin A T制限ピンA 	1	AA1, T4	4	△	DP-1
137	T-stopper pin B T制限ピンB 	1	AA1, T7	4	△	DP-1
138	ASA dial base plate t=0.5 ASA受板 	1	AA1, T6	4	△	DP-1
139	ASA stopper pin ASA制限ピン 	1	AA1, T6	4	△	DP-1 S-1078
140	T 3rd gear T三番ギア 	1	AA1	4	○△	DP-1
141	T gear shaft A Tギア軸 A 	1	AA1, T5	4	△	DP-1
142	T-gear shaft B Tギア軸 B 	1	AA1, T5	4	△	DP-1
143-1	R pinion washer 1.1×2.5×0.1 Rピニオンワッシャー 	1	AA1, EE1	2	○△	
144-1	Spring collar バネカラー 	1	AA1, EE1	2	○△	
145-1	T-gear adjuster t=0.6 Tギア調整板 	1	AA1, T5	4	△	DP-1
146	Common contact piece t=0.11 接触板用導体 	1	AA1, HH1	3	△	DP-1
147	Washer 0.03 A 2.1×2.9× 0.05 B ローラー調整ワッシャー 0.1 C 	各4	AA1, HH3	3	△	DP-1 S-2030
148	Brush bracket ブラシブラケット 	1	AA1, H2-2	3	△	DP-1





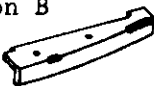

Part No. 部品番号	Name and Shape 名称および形状	Pcs. per Unit 1台分個数	Reference Subassembly No. 参照部品番号	Reference Fig. No. 参照図番	Term of Sale 販売区分	Remarks 備考
149	T-1st,2nd gear T-二番ギア 	1	AA1	4	○	DP-1
150	Resistor gear 抵抗ギア 	1	AA1, HH3,H5	3	△	DP-1 S-8189A
151-1	Brush gear 連動大ギア 	1	AA1,HH3	3	○△	DP-1
152-1	R pinion Rピニオン 	1	AA1,EE1	2	○△	
153-2	Resistor 印刷抵抗体 	1	AA1, HH3,H5	3	△	DP-1
154-2	Brush plate t=0.15 ブラシ板 	1	AA1,H2-2	3,2	△	DP-1
155-2	Brush ブラシ部 	4本組 1	AA1,H2-2	3	△	DP-1
156	Brush C ブラシ C 	1	AA1,H2-2	3	△	DP-1
157	Brush rivet ブラシリベット 	1	AA1,H2-2	3	△	DP-1
158	Insulating washer 1.8 × 3 × 0.2 ブラシ絶縁ワッシャー 	2	AA1,H2-2	3	△	DP-1
159	Brush insulatating ブラシ絶縁座 	1	AA1,H2-2	3	△	DP-1
160-1	Switch contact A & B スイッチ接片 A・B 	2		3	○	DP-1
161-1	Rivet スイッチリードカシメピン 	1	AA1,F2-1	3	△	DP-1
162-1	Switch lead t=0.2 スイッチリード 	1	AA1,F2-1	3,6	△	DP-1
163-1	Earth spring t=0.25 アースバネ 	1	AA1	3	○△	DP-1





Part No. 部品番号	Name and Shape 名称および形状	Pcs. per Unit 1台分個数	Reference Subassembly No. 参照部組品番号	Reference Fig. No. 参照図番	Term of Sale 販売区分	Remarks 備考
164-1	Printed switch スイッチプリント 	1	AA1, F2-1	3, 6	△	DP-1
165 a - d	Semi-fixed resistor 半固定抵抗 	各 1	a F1 b AA1, F2-1 c AA1, F2-1 d F1	3, 5, 6	○△	DP-1
166	Earth brush t=0.16 アースブラシ 	1	AA1	3, 6	○△	DP-1 S-8182
167-1	Contact stand 接触板柱 	1	F2-1	3, 6	△	DP-1
168	Contact pin 接触針 	1	AA1, F2-1	3, 6	○△	DP-1
169-1	Brush bracket liner t=0.3 ブラシブラケット座 	1	AA1	3	○△	
170	Fixed resistor 固定抵抗 	1	F1	5, 6	○△	DP-1
171	Switch guide スイッチガイド 	1	AA1	3	○△	DP-1
172	Meter stand メーター柱 	1	AA1	3	○△	DP-1
173	Screw 接点ビス 	1	AA1	3, 6	○△	DP-1
174	Switch collar スイッチカラー 	1	AA1	1	○△	DP-1
175	Switch button スイッチ釦 	1	AA1, H4	1	△	DP-1
176	Switch rod スイッチロッド 	1	AA1, H4	1	△	DP-1
Blank 欠						
178	Dust cover A t=0.5 防ジン板 A 	1	AA1, H8	3	○△	DP-1













Part No. 部品番号	Name and Shape 名称および形状	Pcs. per Unit 1台分個数	Reference Subassembly No. 参照部組品番号	Reference Fig. No. 参照図番	Term of Sale 販売区分	Remarks 備考
179	Dust cover B t=0.25 防ジン板 B 	1	AA1,H8	3	○△	DP-1
180	Switch spring d=0.3 スイッチバネ 	1	AA1	1	○△	DP-1
181	Window frame A 窓枠 A 	1	AA1	1	○△	DP-1
182	Window frame B 窓枠 B 	1	AA1	1	○△	DP-1
Blank 欠						
184	Washer 12x13.5x 0.1 A 0.2 B ASAツマミ調整ワッシャー 	1	AA1	4	○△	DP-1 S-2048
185	Window plate (clear) 透明窓 	1	D1	1	○△	DP-1
186	Window plate (opal) 乳白色 	1	D1	1	○△	DP-1
187	Meter 検流計 	1	AA1,H8	3,6	△	DP-1
188-1	Mirror holder t=0.2 ミラー受板 	1	CC2	5	○△	
189	Side cover holder t=0.4 スソカバー押え A 	1		5	○	DP-1 S-8169A
190	Side cover holder t=0.4 スソカバー押え B 	1		5	○	DP-1 S-8170A
191-1	Eyepiece lens case 接眼枠 	1	M1	5	△	DP-1
191A	Eyepiece ring 接眼ネジ 	1	M1	5	△	DP-1 S-8052A
192	Eyepiece mask t=0.3 (A) t=0.5 (B) t=0.7 (C)  各1	各1		5	○	DP-1 S-8168A















Part No. 部品番号	Name and Shape 名称および形状	Pcs. per Unit 1台分個数	Reference Subassembly No. 参照部組品番号	Reference Fig. No. 参照図番	Term of Sale 販売区分	Remarks 備考
193	Lens frame 硝子押え 	1		5	○	DP-1 S-3066
194-1	Eyepiece leatherette t=0.5 接眼枠用皮 	1		5	○	DP-1 S-3518
195	Eyepiece spacer 接眼間隔環 	1		5	○	DP-1 S-3060A
196	Prism cover t=0.3 プリズムカバー 	1		5	○	DP-1 S-3072
197	Prism retainer プリズム押え 	2		5	○	DP-1 S-8167A
198	Aperture mask 視野枠 	1	BB1	5	○△	DP-1 S-8104A
199	Bottom plate spring 足バネ 	2	BB1	5	○△	DP-1 S-1530A
200-1	Front side spring 取付けバネ 	1	BB1, B3	5	△	DP-1 S-1579A
201	Lock pin 取付けピン 	2	BB1, BB2	5	△	DP-1 S-1104
202-1	Front attaching button 前取付けボタン 	2	BB1, BB3	5	△	DP-1 S-1066
203	Rear attaching button 後取付けボタン 	2	BB1	5	○△	DP-1 S-1074
204	Washer 1.9x3.2x 0.2(A) 座金 0.3(B) 0.4(C) 	各 4		5	○	DP-1 S-2034A
205D	Washer 1.6x2.8x0.05 調整ワッシャー 	1	BB1	5	○△	DP-1 S-2029A
205A	Washer 1.6x2.8x0.1 調整ワッシャー A 	5	BB1	2,5	○△	DP-1 S-2026A
205B	Washer 1.6x2.8x0.2 調整ワッシャー B 	6	AA1, EE1, EE3	2,5	○△	DP-1 S-2026A













Part No. 部品番号	Name and Shape 名称および形状	Pcs. per Unit 1台分個数	Reference Subassembly No. 参照部組品番号	Reference Fig. No. 参照図番	Term of Sale 販売区分	Remarks 備考
205C	Washer 1.6x2.8x0.3 調整ワッシャー C 	5	BB1	2,5	○△	DP-1 S-2026A
206	Contact pin 端子ピン 	2	BB1	5	○△	DP-1
207	Insulating bush 絶縁ブッシュ 	1	AA1	3,5	△	DP-1
208	CdS retainer t=0.3 受光体押え 	1		5	○	DP-1
209	CdS 受光体 	2	F1	5,6	○△	DP-1
210	Printed circuit t=1 受光体プリント 	1	F	5,6	△	DP-1
211	Diaphragm t=0.1 絞り板 	2	C1	5	○△	DP-1 S-2044A
212	Contact t=0.3 電源接片 	3	F1	5,6	○△	DP-1
213	Sponge A モルトプレン A 	1		5	○	DP-1 S-3527
214	Sponge B モルトプレン B 	2	BB1, BB2	5	○△	DP-1 S-3524
215	Prism side cushion A スソゴム A 	1		5	○	DP-1
216	Prism side cushion B スソゴム B 	1		5	○	DP-1
217	CdS holder 受光体ホルダー 	2	C1	5	○	DP-1
218	Lug t=0.3 ラグ板 	2	AA1	3,6	○△	DP-1 S-4240
219	Lead wire D=0.8 (R) リード線 	1	AA1	6	○△	DP-1









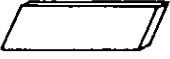

Part No. 部品番号	Name and Shape 名称および形状	Pcs. per Unit 1台分個数	Reference Subassembly No. 参照部組品番号	Reference Fig. No. 参照図番	Term of Sale 販売区分	Remarks 備考
220	Collar スソゴム用カラー 	4		5	○	DP-1 S-2025A
221	N2x1.6 止めナット	1	AA1	3	○△	DP-1
222	E clip A (E-10) Eリング A	8	AA1, BB1, DD2 EE1, EE3	1, 2 3, 5	○△	DP-1
223	E clip B (E-13) Eリング B	1	AA1, EE1, EE3	2	○△	DP-1
224-1	Screw ⊕ 1.4 × 1.8 足ハネ取付ビス 	6	BB1	5	○△	DP-1 S-0031A
225	Screw ⊖ 1.7 × 3.6 ASAツマミビス 	3	AA1	4	○△	DP-1
226	JCIS ⊕ PM1.7 × 4 Type (1)	4		5, 2	○	DP-1
227	JCIS ⊕ PM1.4 × 1.4 Type (1)	2	AA1	3, 2	○△	DP-1
228	Screw ⊖ 1.7 × 2.5 	3	AA1	3	○△	DP-1
229	(45°) 1.7Q × 3	2	AA1	4	○△	DP-1
230	Screw ⊕ 1.7 × 2 	4		1	○	DP-1
231	JCIS ⊕ PM1.7 × 2.2 Type (1)	1		4	○	DP-1
232-1	Screw 1.7 × 3 	2		1	○	S-0128C
233	SC1.7 × 2	2	AA1	4	○△	DP-1
234-1	Washer 3.6 × 4.6 × 0.3 バネワッシャー 	1		2	○	

Part No. 部品番号	Name and Shape 名称および形状	Pcs. per Unit 1台分個数	Reference Subassembly No. 参照部組品番号	Reference Fig. No. 参照図番	Term of Sale 販売区分	Remarks 備考
Blank 欠						
236	JCIS ⊕ PM1.7 × 2.5 Type (3)	2		5	○	DP-1
237	JCIS ⊕ PM1.7 × 2.8 Type (3)	4	AA1, F1	3, 4, 5	○△	DP-1
238	JCIS ⊕ PM1.7 × 2.8 Type (1)	6	AA1	3, 5	○△	DP-1
239	Screw 1.7 × 4 	1	AA1	5	○△	DP-1
240	JCIS ⊕ PM2 × 6 Type (3)	1		5	○	DP-1
Blank 欠						
242	SR1.4 × 2.5	4	BB1, CC5	2, 5	○△	DP-1
243	SR1.7 × 2.5	1	AA1	4	○△	DP-1
244	SC1.7 × 3.5	2	AA1	4, 5	○△	DP-1
245	JCIS ⊕ PM1.7 × 5 Type (3)	2		5	○	DP-1
246-3	Screw 1.4 × 2.5 	5	AA1, EE1	2, 4	○△	S-0037C
247	Screw 1.4 × 2.1 	2		5	○	DP-1 S-0034A
248-1	Screw 1.7 × 3 	3		2	○	DP-1 S-0127A
249-1	Hook A spring stud フックA パネ掛け 	1	AA1, EE1, EE3	2	△	

Part No. 部品番号	Name and Shape 名称および形状	Pcs. per Unit 1台分個数	Reference Subassembly No. 参照部組品番号	Reference Fig. No. 参照図番	Term of Sale 販売区分	Remarks 備考
250-1	Hook B spring axle フック B パネ軸 	1	AA1, EE1,EE3	2	△	
251-1	Lock link joint screw 着脱連動環ビス 	1	AA1, EE1,EE3	2	△	
252-1	Release lever stopper screw 着脱レバー止めビス 	1	AA1	1	○△	DP-1
253	Screw 1.4 × 1.5 ローラー押えビス 	3	AA1,HH3	3	○△	DP-1 S-0036
254	Screw 1.7 × 1.8 調整板ビス 	2	AA1,HH3	3	○△	DP-1 S-0111A
255	Lever bearing screw B レバー座ビス B 	1	AA1	1	○△	DP-1
256	Screw 1.7 × 3 プリントアースビス 	1		5	○	DP-1 S-0128A
257	⊕ CM 1.7 × 2.5 レバー座ビス	1	AA1	1	○△	DP-1
258	T dial axle screw T ダイアル軸ビス 	1	AA1	4	○△	DP-1
259	Lead wire D=0.8 (B) プリント板用リード 	1	F1	3,5,6	○△	DP-1
260	JCIS ⊕ PM1.7 × 4 Type (3)	2		5	○	DP-1
261-1	Hook A t=0.8 フック A 	1	AA1, EE1,EE3	2	△	
262	Hook B フック B 	1	AA1, EE1,EE3	2	△	DP-1 S-8166A
263-1	Hook B spring d=0.5 フック B 用パネ 	1	AA1, EE1,EE3	2	△	
264	Hook A spring d=0.3 フック A 用パネ 	1	AA1, EE1,EE3	2	△	

Part No. 部品番号	Name and Shape 名称および形状	Pcs. per Unit 1台分個数	Reference Subassembly No. 参照部組品番号	Reference Fig. No. 参照図番	Term of Sale 販売区分	Remarks 備考
265	Hook spring stud A フック用バネ掛け A 	1	AA1, EE1,EE3	2	△	DP-1 S-1090
266-1	Hook spring axle A フックバネ軸 A 	1	AA1, EE1,EE3	2	△	
267	Lock link joint 着脱連動環 	1	AA1, EE1,EE3	2	△	DP-1 S-8179
268-1	Link A t=0.4 連動板 A 	1	AA1, EE1,EE3	2	△	
269	Link B t=0.4 連動板 B 	1	AA1, EE1,EE3	2	△	DP-1 S-8177
270-1	Hook B axle フック B 軸 	1	AA1, EE1,EE3	2	△	
271	Hook axle フック軸 	2	AA1, EE1,EE3	2	△	DP-1 S-1089
272	Bush 押込ブッシュ 	2	BB1	5	△	DP-1 S-3050
273	Link joint pin A 連動ピン A 	2	AA1, EE1,EE3	2	△	DP-1 S-1076
274-1	Release lever knob 着脱レバー 	1	AA1,M2	1	△	DP-1 S-3058
275-1	Release lever bearing 着脱レバー座 	1	AA1	1	○△	DP-1 S-8050A
276	Link joint pin B 連動ピン B 	2	AA1, EE1,EE3	2	△	DP-1 S-1077
277-1	Release lever came 着脱カム 	1	AA1	1	○△	DP-1 S-2408
278	Release lever leatherette 着脱レバー用擬革 	1	AA1	1	○△	DP-1 S-3523
279-1	Release lever spring d=0.4 着脱レバーバネ 	1	AA1	1	○△	DP-1 S-1570A

Part No. 部品番号	Name and Shape 名称および形状	Pcs. per Unit 1台分個数	Reference Subassembly No. 参照部組品番号	Reference Fig. No. 参照図番	Term of Sale 販売区分	Remarks 備考
280-1	Release lever knob insert 着脱レバー角孔板 	1	AA1,M2	1	△	DP-1 S-8049
281-1	Release lever stopper 着脱回転ストッパー 	1	AA1	1	△	DP-1 S-1102
Blank 欠						
283	Finder locating pin 取付前ピン 	1	BB1,BB2	1,5	△	DP-1 S-1105
284-1	Name plate t=0.3 貼 銘 板 	1		5	×	
285	Hook collar shaft フック用カラー軸 	1	AA1, EE1,EE3	2	△	DP-1 S-1114
286	Collar フック用カラー 	1	AA1, EE1,EE3	2	△	DP-1 S-8042A
287	E clip C (E-07) E リング C	3	AA1, EE1,EE3	2	○△	
288	Roller screw ローラービス 	2	AA1, HH3,H6	3	△	
289	Sponge C モルトブレン C 	2	CC6	2	△	
291	Roller base plate ローラーフレーム 	1	AA1, HH3,HH6	2,3	△	DP-1
292	Roller adjusting plate t=0.4 ローラー調整板 	1	AA1, HH3,H7	3	△	DP-1 S-8180
293	Brush gear roller 大ギア用ローラー 	2	AA1,HH3	3	○△	DP-1
294	Resistor gear roller 抵抗ギアローラー 	2	AA1,HH3	3	○△	DP-1 S-8047
295	Roller shaft A ローラー軸 A 	2	AA1, HH3,HH6	3	△	DP-1 S-1103A

Part No. 部品番号	Name and Shape 名称および形状	Pcs. per Unit 1台分個数	Reference Subassembly No. 参照部組品番号	Reference Fig. No. 参照図番	Term of Sale 販売区分	Remarks 備考
G1	Mirror ミラー 	1	CC2	5	△	
G2	F 0-lens F 0 レンズ 	1	CC3	5	△	
G3	Rhomboidal prism ヒシ型プリズム 	1	CC3	5	△	DP-1
G4	Pentagonal prism ペンタプリズム 	1	CC3	5	△	DP-1
G5	Eyepiece lens (convex) 接眼凸レンズ 	1	C4	5	△	DP-1
G6	Eyepiece lens (concave) 接眼凹レンズ 	1	C4	5	△	DP-1
G7	Light acceptance prism 受光プリズム 	2	CC3	5	△	DP-1
G8	Light acceptance lens 受光レンズ 	2	C1	5	△	DP-1
G9	F mirror F ミラー 	1	CC5	2	△	DP-1
G10A	F prism A Fプリズム A 	1	CC6	2	△	
G10B	F prism B Fプリズム B 	1	CC6	2	△	

2. Subassembly list

部組品一覧表

20FD11-R.2107.A

No. of Subassembly 部組品番号	Name 名 称	Pcs. per Unit 1台分個数	No. of Constituent parts 構成部品番号	Reference Fig. No. 参照図番 号	Remarks 備 考
AA1	Meter body メーター本体部	1	EE1, F2-1, HH1, H2-2, HH3, H4, H8, M2, T1, T2, T4, T5, T6, 1, 98, 102, 105-1, 109, 110, 119, 126-1, 127, 129, 133, 134, 135, 140, 149, 163-1, 166, 169, 171, 172, 173, 174, 180, 181, 182, 184, 207, 218, 219, 221, 225, 227, 228, 229, 233, 238, 239, 243, 244, 252-1, 255, 257, 258, 275-1, 277-1, 278, 279-1, 281-1, 300-1	3	
BB1	Prism box assembly プリズムボックス組品部	1	B3, 198, 199x2, 203x2, 205A-Cx2, 205D, 206x2, 222x2, 224x6, 242x2, 283, 2-1, 201x2, 214x2	5	DP-1
B3	Front side spring 取付バネ部	1	200-1, 202-1x2	5	DP-1
C1	Light acceptance lens 受光レンズ部	1	3, 211x2, 217x2, G8x2	5	DP-1
CC2	Mirror ミラー部	1	188-1, G1	5	
CC3	Pentagonal prism ペンタ部	1	G4, G2, G3, G7x2, 51-1, 177	5	
C4	Eyepiece lens 接 眼 部	1	G5, G6	5	DP-1
CC5	F mirror F ミラー部	1	G9, 39-1, 40-1, 42-1, 242x2	2	
CC6	F prism F プリズム部	1	G10, 38-1	2	
D1	Top cover 上カバー部	1	4, 68, 69, 71, 85, 185, 186	1	DP-1
DD2	Front cover 前カバー部	1	8-1, 23-1, 25-1, 28-1, 30-1, 48-1, 49-1, 222	1	

Subassembly list

部組品一覧表

20FD11-R.2107.A

No. of Subassembly 部組品番号	Name 名 称	Pcs. per Unit 1台分個数	No. of Constituent parts 構成部品番号	Reference Fig. No. 参照図番 号	Remarks 備 考
EE1	Pantagraph パンタ部	1	EE2, EE3, 13-1, 17-1, 21-1, 66-1, 70-1, 83-1, 143-1, 144-1, 152-1, 246-3×3, 287×2	2	
EE2	Front plate 前板部	1	6-1, 14-1, 16-1, 19-1, 20-1, 24-1×4, 26-1×2, 29-1, 31-1, 37-1, 41-1, 43-1, 44-1, 45-1, 47-1, 56-1, 57-1, 58-1, 59-1, 60-1, 61-1, 62-1, 63-1, 64-1, 65-1, 78-1, 84-1	2	
EE3	Rear plate 後板部	1	7-1, 9-1, 10-1, 11-1, 12-1, 15-1, 18-1, 24-1×3, 26-1×2, 32-1, 33-1, 34-1, 35-1, 36-1, 46-1, 52-1, 54-1, 55-1, 79-1, 80-1, 81-1, 222, 223, 249-1, 250-1, 251-1, 261-1, 262, 263-1, 264, 265, 266-1, 267, 268-1, 269, 270-1, 271, 273, 276, 285, 286, 287, 22-1	2	
F1	CdS-printed circuit CdSプリント板部	1	210, 82×2, 86, 89, 93, 94, 132×4, 165a, 165d, 170, 209×2, 212×3, 237×4, 259	5, 6	DP-1
F2-1	Printed switch circuit スイッチプリント板部	1	164-1, 160-1×2, 161-1, 162-1, 165b, 165c, 167, 168	3, 6	DP-1
HH1	Common contact base 接触板部	1	122, 108-2, 146, 207	3	
H2-2	Brush ブラシ部	1	148, 154-2, 155-2, 156, 157, 158×2, 159	2, 3	DP-1
HH3	Roller base ローラーフレーム組品部	1	HH6, H5, H7, 147×2, 151-1, 253×4, 254×2, 293×2, 294×2, 298×2	3	DP-1
H4	Switch button スイッチボタン部	1	175, 176	1	DP-1
H5	Resister gear 抵抗ギヤ部	1	150, 153-2	3	DP-1
HH6	Roller base plate ローラーフレーム部	1	291, 295×2	3	DP-1

Subassembly list

部組品一覧表

20FD11-R.2107.A

No. of Subassembly 部組品番号	Name 名 称	Pcs. per Unit 1台個数	No. of Constituent parts 構成部品番号	Reference Fig. No. 参照図番	Remarks 備 考
H7	Roller adjusting plate ローラー調整板部	1	292,296,297x2,299	3	DP-1
H8	Meter メーター部	1	187,178,179	3	DP-1
M1	Eyepiece lens case 接眼枠部	1	191,191A	5	DP-1
M2	Release lever knob 着脱レバー部	1	274,280	1	DP-1
T1	T-film T フィルム部	1	114,104,106,107	3	DP-1
T2	T-drum T フィルムプーリー部	1	128-1,T3,117	4	DP-1
T3	T-film pulley T プーリー部	1	111,115	3	DP-1
T4	T-bottom cover T 底板部	1	121,136	4	DP-1
T5	Racket plate 羽子板部	1	123,141,142,145	4	DP-1
T6	ASA dial knob ASAツマミ部	1	124,125,131,138,139	4	DP-1
T7	T-dial T ダイアル部	1	130,137	4	DP-1